

Fifty Years of X-Ray Diffraction, Commemoration Meeting,
Munich, July 25, 1962

The development of methods and instrumentation for crystal-structure analysis

By **M. J. BUEGER**

Massachusetts Institute of Technology, Cambridge, Massachusetts

It is obvious that progress cannot be made in an experimental science without apparatus, so it is of interest to look back over the fifty years of x-ray diffraction to trace the development of the apparatus it uses. It had been my original intention to speak only of the development of instrumentation, but I found it unreasonable to divorce instrumentation from the theory and methods which accompany the instruments. Furthermore, it is impossible to cover the entire field of developed instrumentation, so I thought it best to confine attention to the highlights in the development of instruments for crystal-structure analysis.

An interesting conclusion can be stated in advance: Though we have many pieces of convenient apparatus now, a good fraction of the main lines of development had already been initiated within a few years after the discovery of x-ray diffraction, and even the Weissenberg method was invented at the end of the first ten years. More recent developments have been largely concerned with convenience, elegance, refinement and automation. It is apparent, then, that the early workers had a keen appreciation of what was required and how to arrange to get it.

I would like to start my remarks with a few observations about sources of x-rays. The earliest sources were x-ray 'bulbs'. These can probably be described as sealed-off gas tubes without adequate cooling or provision for regulating the gas pressure. They were certainly capricious, and BRAGG speaks with feeling about their operation. I did not enter the diffraction field until about 1930. By that time the sealed-off hot-cathode Coolidge tubes were available but usually were

unreliable. After trying several whose lives did not exceed 90 hours, I turned to the metal-bodied continuously pumped gas tubes devised by SCHERRER, as did many experimenters of that era. Each experimenter had his own favorite design and usually made the tube in his own shop, but most of them followed the older Scherrer or newer Hadding designs. Those who used these tubes perforce became experts in vacuum systems. These sources were also capricious and would behave unpredictably because of leaks or dirt in the system. Nevertheless, such a satisfactory system based upon a modified Hadding tube and a circulatory vacuum system was evolved in my laboratory that I gave it up only with reluctance when the Coolidge tube became perfected commercially. In the United States the General Electric Company sold the first really satisfactory tube, and, with the advent of their CA-4 in about 1940 we were, for the first time, in a position to purchase x-radiation rather than to make it, so to speak. This removed one of the several barriers to crystal-structure analysis. Modern x-ray tubes are very reliable, and are usually guaranteed for 1000 hours of service; indeed, it is not an uncommon experience to have a tube last for 10,000 hours.

The first method used in x-ray diffraction was, of course, the Laue method. Because of the continuous wavelength spectrum and the variation of other features dependent upon wavelength, this method has been abandoned for investigations which are primarily crystal-structure analyses. Yet there was a time, around 1930, when the Laue method was used as a normal part of the routine of determining both cell dimensions and atom locations. But this was in the days when reflections were made from extended crystal faces, when absorption was neglected, and when scattering factors were approximated by big and little integers. The chief continued use of the Laue method has been in the detection of symmetry of a single crystal by making use of the corresponding centrosymmetry of the Laue photograph, and in the determination and improvement of the orientation of single crystals.

The only substantial change that was made in the Laue method was the devising of the back-reflection Laue method by GRENINGER in 1935. Curiously enough, this was a retrogression to the first unsuccessful experiment by FRIEDRICH and KNIPPING. It was made successful in this case by application to metal crystals with small spacings. The advantage of the back-reflection Laue method is that its geometry permits the Laue cones and the locations of their intersections to be

recorded with little distortion on the film. This makes it comparatively easy to see the projected symmetry of the crystal, and thus to measure and correct an orientation error.

Chronologically, the second method of x-ray diffraction detection was the spectrometer method of the BRAGGS. Few other laboratories made much use of this method until recently, when superior quantum detectors permitted it to arise again as the diffractometer method, about which more will be said later.

The powder method was discovered by DEBYE and SCHERRER only three years after the discovery of x-ray diffraction, and rediscovered independently in the United States a year later by HULL. The original powder camera had many of the essential features still found in our powder cameras 47 years later. As we look back at it, we see that the pinhole system is already present in essentially its present form, that the beam leaves the camera through a hole in the film, that the film is laid against the inside of a brass tube and that the camera can be returned accurately to its adjusted position. All these are features of the present day powder cameras, a testimony to the perception of the original designers. Modern powder cameras have a few new features, some devised for sheer convenience, others dictated by theory not yet developed in 1915.

The powder method split off several side lines and corresponding instruments, including semi-focussing cameras, small-angle cameras, and diffractometers. Three years after DEBYE and SCHERRER invented the powder method, SEEMANN, and later BOHLIN, utilized the Bragg semi-focussing condition to devise the semi-focussing powder camera. This method is characterized by short exposures and dispersions double that of the Debye-Scherrer camera of the same radius, but limited range of recording. Such cameras were made popular in metallurgical research by WESTGREN. Metallurgists also use a crude variation of this for studying small changes in individual back-reflection Debye rings. BOZORT and HAWORTH added to this by bringing convergent monochromated radiation to the slit from a curved crystal. GUINIER, DE WOLFF, HOFFMANN and JAGODZINSKI all added improvements to the method.

Apparently small-angle scattering was discovered by GREY and SULIN in 1930. It was used by KRATKY shortly thereafter, by WARREN on carbon black in 1934, by CLARK and his school on cellulose, collagen, keratin and rubber in 1935, and by FANKUCHEN and others on liquid crystals in 1936. Later the subject was extensively developed by

GUINIER, WARREN, HOSEMANN and others. The apparatus was essentially a powder camera which recorded only a few degrees 2θ , but with great attention to the geometry of the pinhole system, beam, specimen and beam trap.

The application of quantum counters to powder diffractometers got its start in the United States during World War II when many engaged in trying out various methods to use in the routine orientation of quartz crystals to be used piezoelectric oscillators. Under the hand of WILLIAM PARRISH, the Geiger-counter method proved the best for this purpose and, after the war, PARRISH was instrumental in having North American Philips develop the powder diffractometer to a fine instrument which permitted making accurate measurements of diffraction intensities. Later the proportional counter and scintillation counter extended the linearity range of this instrument and reduced the background of its results.

As with other methods of recording diffraction, the rotating-crystal method had its start at the very beginning, for DE BROGLIE took photographs by this method as early as 1913. But until SCHIEBOLD began to use it as a routine method of crystal investigation in 1919 it achieved no popularity. Shortly thereafter POLANYI used the method for the study of fiber structures.

It appears that in the early days of crystal-structure analysis the rotating-crystal method was not always trusted to give data leading to cell dimensions. Curiously enough, many investigators derived this information from the Laue method, the use of which required a knowledge of the maximum potential across the x-ray tube.

The rotating-crystal method took a more favorable position with the appearance of BERNAL's epoch-making 1926 Royal Society paper "On the interpretation of x-ray, single crystal, rotation photographs". This paper gave a new direction to crystal-structure analysis, and laid a foundation for further developments, in particular the development of all the moving-film methods as well as the single-crystal diffractometer methods. Fundamentally BERNAL made practical a theoretical base which had already been laid first by BRAVAIS' invention of the polar lattice in 1850, and EWALD's use of it in 1921 to give a geometrical interpretation of BRAGG's Law. With the publication of BERNAL's paper, the reciprocal lattice began to become popular, and gradually all x-ray crystallographers came to think in terms of it. BERNAL made this easy for us, basically by his discussion, but also by furnishing us with a net which provided the cylindrical coordinates of reciprocal

space as mapped on a rotating-crystal photograph. This was the first mapping of reciprocal space on the photographic record.

In this we see the working of what I believe to be a principle. The success of instrumentation goes hand in hand with the development of relevant theory. More generally, apparatus and the theory of its use cannot be divorced, but depend on one another for mutual success.

BERNAL's paper caused the rotating-crystal method to assume the role of the common method of x-ray crystallography for many years. With the precaution that the crystal must be small and completely bathed in x-radiation, this method provided a simple reliable means of determining the translations of a cell. It had the advantage over the Laue method that the wavelength producing each diffraction spot was constant, and it had the advantage over the spectrometer method that it required no supervision, and that all fluctuations of the intensity of the primary x-ray beam were time-averaged in such a way that all diffraction spots could be regarded as arising from a constant primary beam.

The pure rotating-crystal method, however, suffered from two serious disadvantages. It gave no direct symmetry information whatever, a discussion of which will be reserved until later, and it suffered from index-indeterminateness. Each spot on the photograph is a function of the three reciprocal-lattice variables, h , k , and l , yet the spot is recorded on a film whose coordinates are limited to two, say x and y . This gives rise to indeterminateness of assigning the indices hkl to the spot, and this characteristic stimulated the development of several other methods.

One of these methods, the oscillating-crystal method, had already been devised, but its advantages had not been appreciated until BERNAL popularized the reciprocal lattice as a tool for interpretation. BERNAL showed that, if the crystal was oscillated through a limited angle rather than rotated through a full cycle, the number of reflections which came up for consideration was limited, and the photograph could be indexed. This was essentially because, although each spot was still located by only two film coordinates, it no longer corresponded to all of three-dimensional space, but only to certain quantized sites located in a fraction of such space. This caused indexing to be determinate for practical purposes. As we look back, it is odd how we were blocked by such a simple thing as indexing. Many crystal-structure analyses failed merely because indexing was uncertain. Tourmaline

provides an example; its structure was so complicated that solving it by guesswork in the wrong space group proved to be out of the question.

It is a curious fact that the oscillating-crystal method had actually been rendered obsolete for two years before BERNAL showed how to use it. In 1924, only 12 years after the discovery of the diffraction of x-rays, WEISSENBERG had already published his epoch-making paper which not only established the Weissenberg method, but also pointed out a philosophy which would be the inspiration for other moving-film methods. But in spite of the new era opened by WEISSENBERG 38 years ago, the conservative nature of the x-ray crystallographer is such that many still use the oscillating-crystal method, and manufacturers still find a market for these obsolete instruments.

The possibility of indexing uniquely a Weissenberg photograph is based upon a feature quite different from the feature which makes it possible to index an oscillating-crystal photograph. In the rotating-crystal method, each cone of the nest of Laue cones records separately as a layer line. If the crystal is rotated about a crystallographic axis, the index of this cone is one of the indices hkl of the reflection. For example, if the crystal is rotated about the c axis, the index of the Laue cone is l . Since the cones are separate, the l index of every spot is determinable because it is mapped against film coordinate y . The indeterminateness resides in h and k which are both mapped against the single film coordinate x . In the Weissenberg method, a particular layer line of known l is isolated, and, by movement of the cylindrical film normal to x (that is, parallel to the rotation axis) the spots of indices hk are spread over the two-dimensional surface of the film; therefore to each hk there corresponds a unique xy . In this way, by treating one Laue cone at a time, the Weissenberg method permits indexing. Once this is established, it is an easy matter to transform hk to xy or the reverse. The greatest convenience results if the hk of reciprocal space is mapped on the xy of the film, not the reverse.

Since 1934, most Weissenberg instruments have been made so that the angle μ , between the direct beam and the normal to the axis of crystal rotation, can be varied. This permits using the equi-inclination technique, for which μ is set so that the direct beam becomes a generator of the Laue cone being investigated. With this technique, there is a great deal of convenient invariance between the records of the different levels. For example, a set of parallel rows of the reciprocal lattice always have the same shape on the photograph.

The uniqueness of the transformation from reciprocal-lattice coordinates to film coordinates makes it possible to map the Friedel symmetry of reciprocal space on the film, so that the Friedel symmetry of the crystal can be recognized from a set of Weissenberg photographs. The Weissenberg method was the first method other than the Laue method to permit symmetry determinations.

An unfortunate anachronism occurred in the development of the Weissenberg method. A line of symmetry in a level of the reciprocal lattice is transformed on a Weissenberg film to a line making an angle with the central base line which depends on the ratio of the coupling constant to camera diameter. Annoyed by the nonsymmetrical appearance of symmetry in the Weissenberg photograph, FERNANDO HUERTA showed that, by giving the cylindrical Weissenberg camera a screw motion, rather than a translation motion, the intersecting lines of symmetry of reciprocal space could be preserved as true symmetry in the Weissenberg photograph. But this was only achieved by complicating an already complicated mechanism. Meanwhile precession cameras with their more faithful symmetry reproduction were already replacing Weissenberg cameras, so the helicoidal Weissenberg motion never became popular. It probably would have achieved popularity if presented 20 years earlier.

The success of the Weissenberg method stimulated the invention of several other methods, the most important of which were the Sauter method and the Schiebold method, both devised about 1932, and so following WEISSENBERG by about eight years. In both these methods the Laue cones are treated one at a time, and in both of them diffraction is recorded on a moving film. The motion is a rotation about an axis normal to the film at its center, and the axis is located in a plane determined by the crystal-rotation axis and the x-ray beam. The

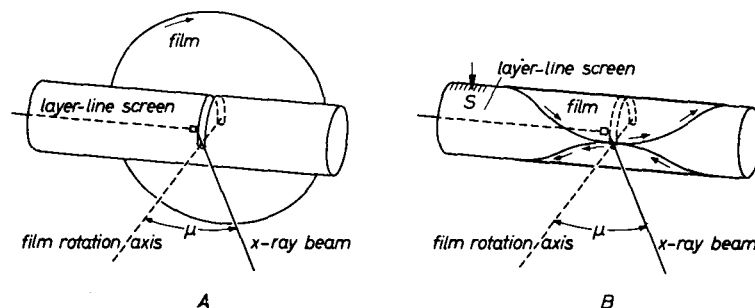

Fig. 1. Relation of film placement in Sauter method (A) and Schiebold method (B)

Sauter method employs a flat film; the Schiebold method employs a film wrapped, rotating-crystal fashion, on a cylinder parallel to the crystal-rotation axis, yet rotating about an axis normal to the cylinder, so that the cylindrical film curvature continually changes with respect to the film coordinates. Both methods have the advantage over the Weissenberg method that the record is a less distorted picture of the reciprocal lattice level. Neither method ever achieved great popularity, the Sauter method because its flat film lacked the recording range of the Weissenberg film, and the Schiebold method because the continually changing film curvature causes serious constructional difficulties. With the development of the de Jong-Bouman method and the precession method, both of which supply a photograph of the reciprocal lattice level without any distortion, these methods lapsed into disuse.

The next major development was concerned with the undistorted photography of the reciprocal lattice. This gave rise to the de Jong-Bouman apparatus on one hand and to the precession instrument on the other. It is a curious fact that the basic features of these two methods were developed independently at about the same time, and with different objectives. In attempting to find a method for uniquely indexing rotating-crystal photographs in 1937, DE JONG and BOUMAN discovered a way of using a rotating crystal to make an undistorted photograph of an upper level of the reciprocal lattice. Later they found a way to extend this to the zero level. Basically, the de Jong-Bouman discovery required that a flat film be placed parallel to the reciprocal-lattice level, and that the film be rotated about an axis

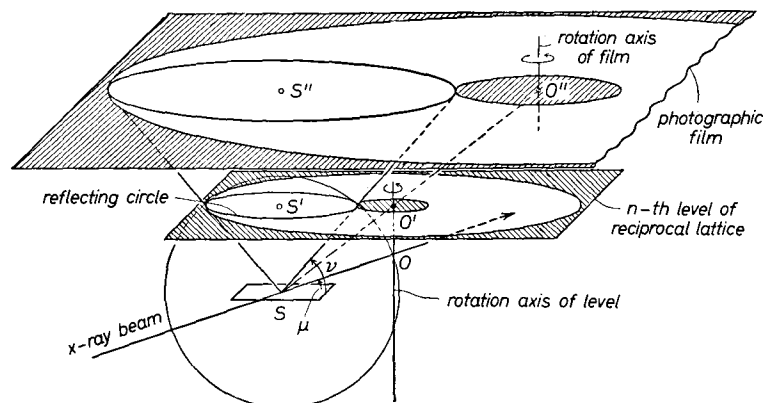

Fig. 2. Geometry of photographing the reciprocal lattice with a rotating crystal by the de Jong-Bouman principle, and making use of an inclined beam

which was the projection of the axis about which the level is rotated. The original apparatus produced by these authors was not readily adaptable to routine x-ray crystallography, partly because the crystal was not mounted on the usual goniometer head, and partly because provision was not made for convenient inclination of the rotation axis to the x-ray beam, already a common feature which gave great flexibility to Weissenberg cameras. An instrument of the de Jong-Bouman type but not having these inconveniences was shown in the

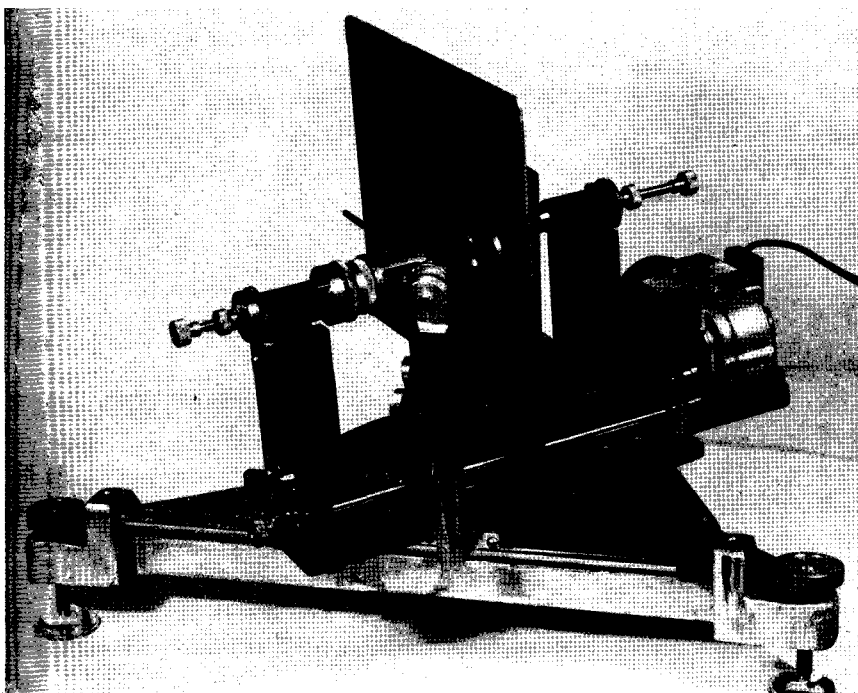

Fig. 3. Instrument which makes use of the geometry of Fig. 2, designed to accept a crystal mounted on a goniometer head

book *X-ray crystallography*, published in 1942. This practical instrument has been used by your lecturer and a generation of his students. A commercial copy but embodying the questionable feature of automatic equi-inclination has been called a "retigraph". The original has some practical features more suited to routine x-ray crystallography.

The precession method offers an alternative way of photographing the reciprocal lattice, but it was not invented for this particular purpose. Whereas the de Jong-Bouman method is an offshoot of the

rotating-crystal method, discovered in attempting to improve its indexing, the precession method was deliberately invented for symmetry purposes as an improvement of the oscillating-crystal method. The only direct symmetry information which the oscillating-crystal method can give is with respect to the axis of the crystal which comes parallel to the x-ray beam at the midpoint of the oscillation. If the Friedel symmetry of this axis of the crystal contains a subgroup of $2mm$, the symmetry of the oscillating photograph reveals what subgroup it is. It cannot reveal whether this axis has Friedel symmetry 3 , $3m$, 4 , $4mm$, 6 , or $6mm$. This is because the symmetry of the oscillation

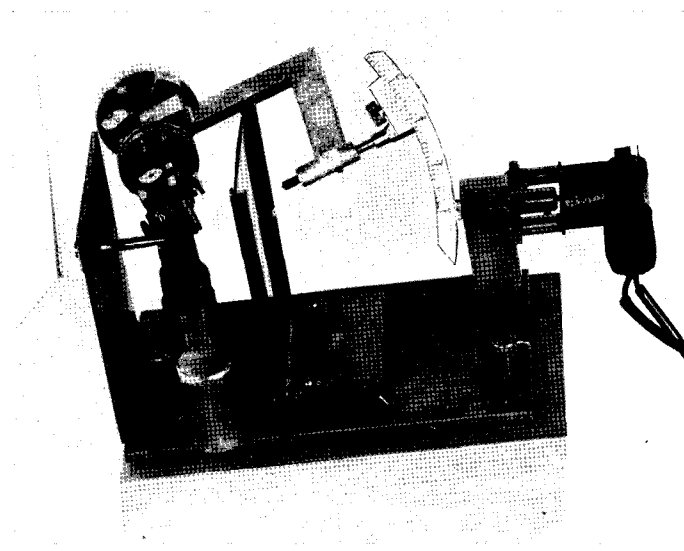

Fig. 4. Early form of precession apparatus (Mark I) not incorporating the generalized de Jong-Bouman principle

is $2mm$. The precession motion was devised to improve the symmetry of the motion so that no point-group symmetry would be degraded by it. It was first used on the Mark I precession camera, which, with its symmetry-true photographs, was first published in the book *X-ray crystallography*.

The photographs made with the Mark I precession camera suffered from a slight radial distortion. When DE JONG and BOUMAN showed how to make undistorted photographs by the rotating-crystal method, it was obvious that, by a generalization of their principle, the distortion could also be removed from the precession photographs. The

result of applying this principle was the Mark II precession camera, which is essentially the precession instrument now in use. Among the advantages of the precession method are that the crystal orientation can be perfected on the instrument, that the entire reciprocal lattice can be surveyed with one mounting of the crystal, and that the cell geometry can be determined with the greatest simplicity and with moderate accuracy. For example, the linear dimensions of the cell can be measured to about 0.2% and the angles to less than 5 minutes without any special precautions.

The advantages of the precession camera have caused it to be produced in the United States, Germany, Netherlands, Switzerland, and Japan. The leading American manufacturer estimates that he has made some 700 precession cameras and 600 Weissenberg cameras. This popularity could not have been achieved without the availability of precisely built commercial versions of the instrument, so we see an example of the fact that theory and the availability of good apparatus must go hand in hand.

Permit me to say a few words about cone-axis photographs because so few of you take full advantage of them. The cone-axis photograph bears the same relation to the precession method that the rotating-crystal photograph bears to the Weissenberg method. A cone-axis photograph can be indexed in the same sense that rotating-crystal photographs can be indexed, with interestingly corresponding ambiguity. There is a curious complementarity between the rotating-crystal photograph and the cone-axis photograph. In the former, the position of a spot in its layer line is determined by the magnitude of the vector from the origin to the reciprocal-lattice point; there is no information about the direction of the vector. For the cone-axis photograph the reverse is true. Between the two, all information about the reciprocal lattice is contained. As a consequence of the directional properties of the cone-axis photograph, the symmetry of the distribution of intensities in each of its rings is the same as the symmetry of the corresponding level of the reciprocal lattice of the crystal. The separation of levels makes it a more powerful and more elegant indicator of the symmetry of an axis than a Laue photograph.

But there is also a curious connection between a Laue photograph and a cone-axis photograph which it is especially appropriate to mention today. This relation was first noticed by D. JEROME FISHER, and can be explained as follows: If one imagines the reciprocal lattice of a crystal, as used with characteristic radiation by the Bernal con-

vention, then for general radiation (that is, for a continuously variable wavelength) the reciprocal lattice is a set of line segments whose directions radiate from the origin through the points defined by the characteristic radiation. For simplicity, let this reciprocal lattice for general radiation be called a *burr*. When the burr is placed at the origin of the sphere of reflection, the intersections of its rays with the sphere are responsible for reflections. The diffracted beams run from the center of the sphere to the collection of intersections, and on to the film. The rays of the burr are coplanar only for various zero levels. Each collection of coplanar rays intersect the sphere in a circular locus whose projection on to the plane of the film is one of the familiar conic-section loci of Laue spots. Now, if the burr is given a precessing motion with the film rigidly attached to it, the result is a cone-axis photograph made with general radiation. The precessing rays of the burr sweep out cones, and the intersection of a cone with the sphere projects from the center of the sphere to the film as a general radiation streak on the cone-axis photograph. The cone-axis photograph is thus seen to be a generalization of a Laue photograph.

The methodology and instrumentation described to this point represent the *status quo* of about 10 years ago. The devices used in the earliest days for investigations in x-ray crystallography were the spectrometer, Laue camera, powder camera, and rotating- and oscillating-crystal cameras. While the powder camera is still used in certain investigations in x-ray crystallography for which the crystal symmetry is high, and when single crystals are not available, the other instruments have now been largely displaced by the Weissenberg camera and precession camera.

Except for the spectrometer, all these instruments record the results on photographic film, so that any measurements of the diffracted intensities must be made from the photographic record. Theory requires that the integrated power of the reflection be measured, not its peak intensity. This calls for obtaining a measure of the integral of the logarithm of the photographic density for each spot, rather than a simple measurement of the peak density of each spot. This has been a source of trouble since the earliest days of quantitative work. Most investigators contented themselves with measurements of peak intensities. Others spend relatively enormous amounts of time in sampling the densities of each spot, converting to exposures, and summing them. Several methods were devised to circumvent this tedious procedure. BRENTANO and his school estimated the integrated power by measuring

the amount of light scattered by the silver particles in the spot. DAWTON devised a method of making positive prints of the original negatives; the light transmissions through the spots could be readily integrated. ASTBURY did much the same using transmission of alpha particles from polonium by the spot in the positive. ROBERSON and DAWTON devised a scheme in which a spot was scanned and its light transmission measured by a photocell and continually transformed to density by a nonlinear circuit. All these methods had drawbacks, so none came into general use.

On the other hand the plateau method provided a simple way of determining integrated intensities. This was first suggested by DEBYE, but did not come into general use until rediscovered and implemented by a practical design for the Weissenberg camera by WIEBENGA. It is now available also for the precession camera. The principle of the device is that the cassette is shifted uniformly after each rotation or precession cycle so that the diffraction spot is spread out over a small area. With proper design, a small central region of the smeared-out spot has a uniform region, or *plateau*, which has received contributions from all regions of the spot, so that its density is proportional to the integrated power of the reflection. AZAROFF also produced a plateau by adding a properly designed bent-crystal monochromator to a precession camera.

The need for integrated reflections also stimulated the development of non-photographic methods of measuring intensities. The basis for such measurement had been laid during and just after the war by the development of the Geiger-counter diffractometer for recording the diffraction from powders. After the war, LONSDALE, WOOSTER and his school, and COCHRAN experimented with recording the diffraction from single crystals, but limited attention to zero-level reflections. Later, McLACHLAN and his school, and HOWARD EVANS made Geiger-counter attachments which fitted Weissenberg instruments and so

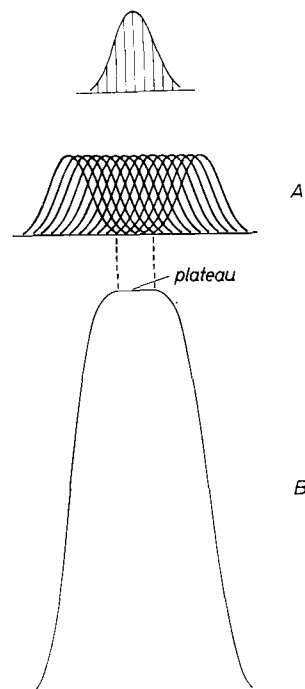

Fig. 5. Production of a plateau, as shown in *B*, by summing the exposures of an x-ray spot recorded at different positions on the film, as shown in *A*

were capable of recording upper levels as well. Counter diffractometers, especially intended for single-crystal diffractometry were designed by BOND, by BUERGER and by FURNAS and HARKER. The superior accuracy in intensity measurement required in modern crystal-structure investigations, especially those involving refinement, calls for the routine use of such instruments.

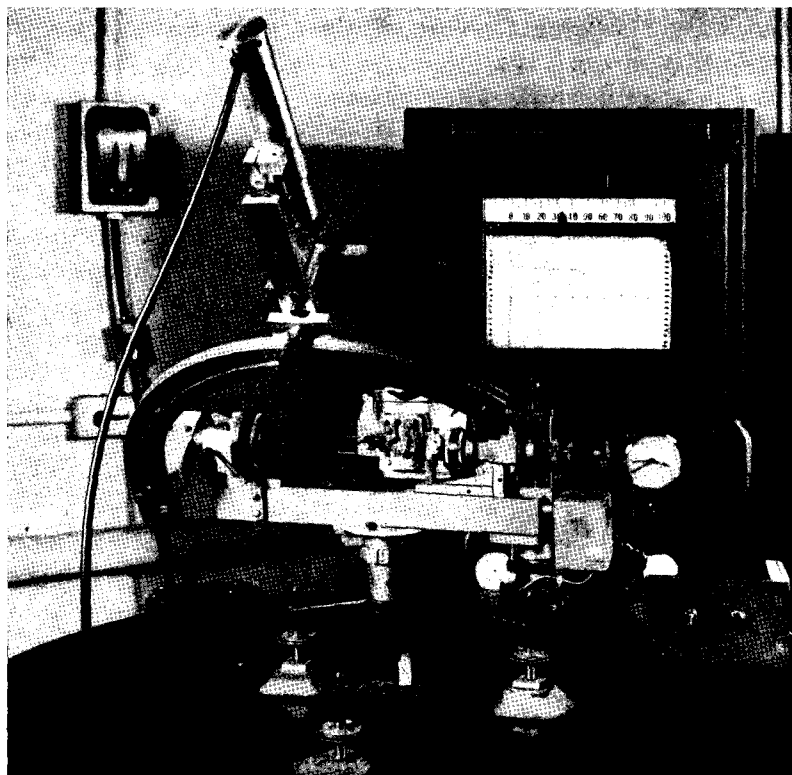

Fig. 6. Early form of single-crystal diffractometer

The entry of the single-crystal diffractometer into crystal structure analysis has brought the development of apparatus around a full cycle to the general method used by the BRAGGS in their first crystal-structure investigations. Again we see what keen perception of the requirements of the problem the first investigators in the field had. It seems likely that most future crystal-structure analyses will be undertaken with single-crystal counter diffractometers, supplemented by Weissenberg or precession instruments equipped with integrating cassettes.

The diffractometer suffers from the disadvantage that it requires attention to set the crystal into reflection position, to set the counter to accept the reflection, and to set the recorder to record its results for each reflection. If this setting is done manually, it is time-consuming and tedious. After four hours of this routine work, mistakes are likely to creep into the operation to the extent that the operation should perhaps be stopped or the operator changed. The total accomplishments in this time is of the order of 25 reflections if reasonable precision is required for each measurement. It is not unusual to consume one or more months in gathering intensity data for an inorganic crystal if it is done manually. It was therefore inevitable that the personal attention of manual operation should be transferred to automatic control and recording. This was fairly easy to accomplish because programs had already been written which permitted transforming the cell geometry into diffractometer settings by high-speed

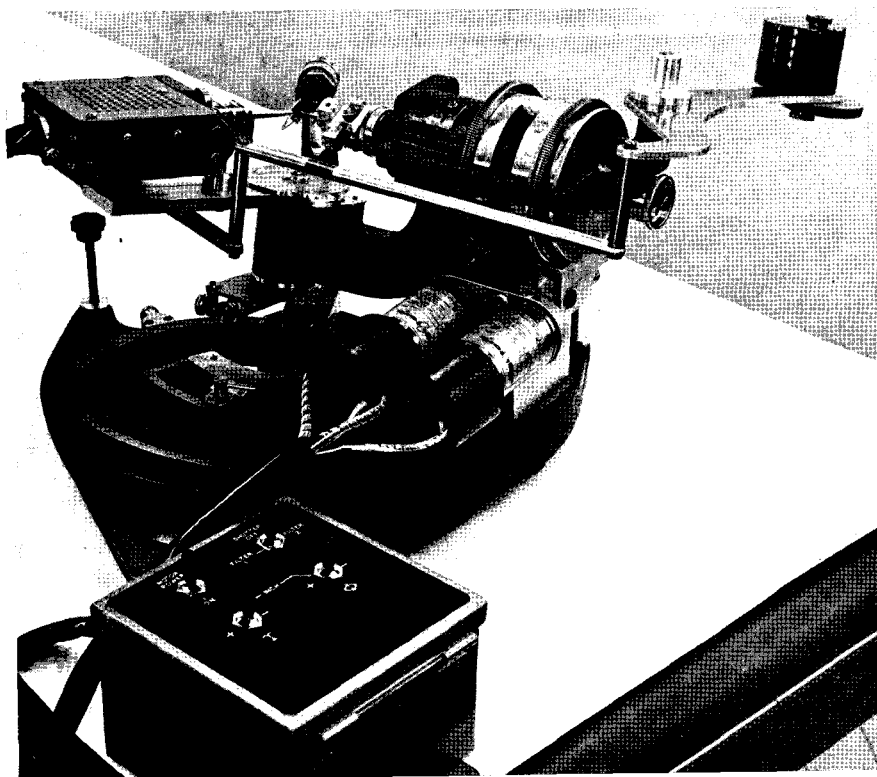

Fig. 7. Late form of single-crystal diffractometer (courtesy of Charles Supper Co.)

computers. All that needed to be added was the controls for setting and recording. Such automation is now available commercially at a cost which makes it advantageous to substitute automation for a manual operator.

Automation has been attained at a most convenient time, for it seems that much of the interesting future work of x-ray crystallography lies in the field of biologically important compounds having rather large cells. Because of the tremendous number of reflections involved it would be as much out of the question to deal with these manually as to carry out manually some of the routine crystallographic computation now submitted to high-speed computers. The fraction of the time many of us have spent on technical features of the analyses is now released by automation and high-speed computation to our successors for their use in the part of the analysis requiring thought. We hope you will make excellent progress with this released time.